

# COMPREHENSIVE CUSTOMER GUIDE

Experience The “Duplessis” Difference

Our Swimming Pools Are Designed for

*The Way You Live*





# TABLE

OF CONTENTS

## 1

### COMPANY BACKGROUND

*Where we started, how its going, and who's been with us along the way*

## 6

### PLANNING STAGE

*Overview of our design process and customizable templates tailored to meet your unique pool design preferences*

## 19

### CONSTRUCTION PROCESSES

*A detailed walkthrough of the stages involved in bringing your custom pool to life with precision and expertise*

## 27

### GALLERY

*Explore completed projects, illustrating the craftsmanship and diverse design possibilities of our custom pools.*

## 30

### TESTIMONIALS

*Hear from satisfied clients who have experienced the exceptional service and quality firsthand*

## 36

### WHY DUPLESSIS?

*Info about what sets us apart, featuring our warranty and commitment to excellence*

## 38

### COMPARISON SHEETS

*Detailed charts outlining the features and benefits of pool options offered by us for informed decision-making.*

## 44

### HAYWARD INFO

*Details on the equipment used and the warranties provided to ensure long-term satisfaction and peace of mind.*



# COMPANY BACKGROUND

A custom swimming pool is an investment in tranquility and beauty that is designed to meet your family's lifestyle and needs. From modest backyard oases to extravagant aquatic paradises, pools come in various sizes and designs, catering to diverse preferences and budgets. At Duplessis Builders, we understand that each homeowner's vision is unique. With our expertise in crafting custom gunite pools, we offer flexibility to tailor the design to meet individual preferences. Our team is committed to bringing your pool dreams to life, enhancing both the aesthetic appeal and the intrinsic value of your home.

Below are just a few reasons why you should consider Duplessis Builders to help transform your backyard into your dream outdoor retreat.

## PERSONALIZED SERVICE

The most frequent compliment we receive at Duplessis Builders is regarding our customer service. With DB, you're not just a client; you're a valued collaborator in the creation of your outdoor oasis. From the initial construction to the final touches, our dedicated team prioritizes open communication and tailored solutions, ensuring that every aspect of your pool reflects your distinct style and requirements. With our personalized service approach, you can trust that your vision will be brought to life with precision, care, and unwavering attention to detail, making the experience of building your pool as rewarding as enjoying its tranquil waters for years to come.

## QUALITY

Our unwavering commitment to excellence is reflected in every project we take on. Partnering exclusively with top-tier suppliers ensures that we source only the finest materials, guaranteeing durability, functionality, and aesthetic appeal. Our dedication to satisfaction extends beyond the project completion with the assurance of the best warranty in the business. With Duplessis, you can trust in the longevity and performance of your investment, backed by our commitment to quality and service excellence.

## EXECUTION

Over the years, we have developed a project management system consisting of detailed processes and procedures. From digital 3D designs to our quality control our average completion time is approximately 8 weeks from excavation to relaxation.

# MEET OUR TEAM



## Derek Duplessis

*Owner*

- 225-910-1130
- Business Development
- Marketing



## Bradie Duplessis

*Owner*

- 225-937-8023
- Business Development
- Office Management



## Jon' Duplessis

*Designer & Media Manager*

- 225-338-8667
- Pool Designer
- Social Media Marketing
- Construction Drawings



## Dawn Ebeyer

*Lead Designer*

- 225-268-4702
- Pool Designer
- Construction Drawings
- Material Specialist

# MEET OUR TEAM



## Kelsey Delaune

Secretary

- 225-937-0414
- Business Development
- AP/AR
- Marketing



## Kolby Delaune

Project Manager

- 225-610-6718
- Schedule and prioritize workload
- Direct field foreman

## Kase Delaune

Construction Foreman

- 225-278-2299
- Supervise day to day field activities
- Quality control

## POOL CONSTRUCTION CENTERED AROUND YOU

At Duplessis Builders, we believe the pool construction process should be efficient, collaborative, and completely centered around you. When it comes to your swimming pool, you have a vision, and it's our job to make it come to life.

We start with clear communication, and we guarantee no surprises. Throughout the design process, planning stage, and well into construction, we work closely together with our clients, every step of the way.

Below we have listed some key project steps, along with what to expect during the various phases of purchasing your new custom pool.



**DESIGNING YOUR DUPLESSIS BUILDERS POOL**

After one of our talented design team members meets with you and your family and takes the necessary measurements of your backyard space, they will begin to create your custom 3D design. These designs are centered around your family's needs, expectations, and the water feature options you've chosen to include in your backyard space.

After the 3D design is complete, our designer will send you a 3D rendering of your design ensuring that everything on your wish list has been included.

Once the design meets your vision and expectations, we will invite you to our showroom where we will discuss the details of the project including material selection options and a detailed cost analysis.



610 SQFT



3.5-5.5 DEEP

# PEBBLE BEACH

5 LED COLOR CHANGING LIGHTS  
7X10 INFINITY SPA WITH SLANTED BACKS &  
ARM RESTS

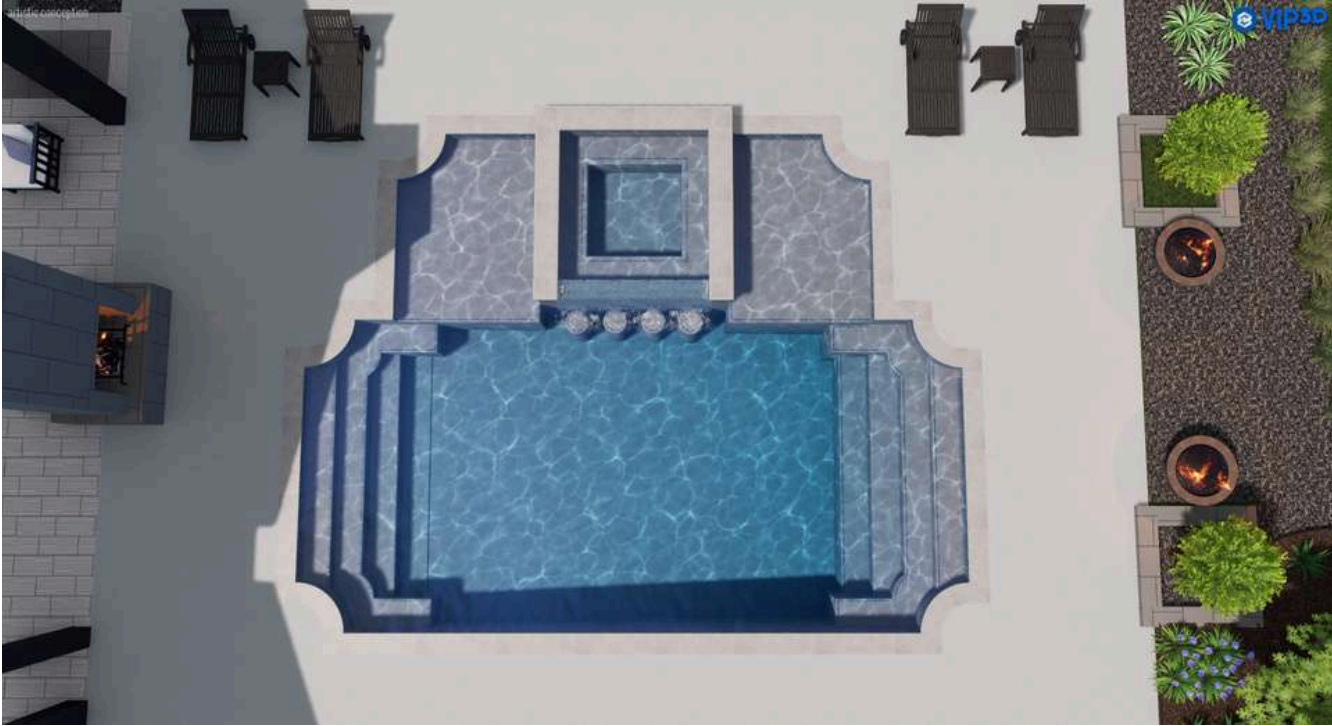

# AQUA VISTA

**670 SQFT**

**6 LED COLOR CHANGING LIGHTS  
8X8 SPA WITH SPILLOVER  
SLANTED BACKS & ARM  
RESTS IN SPA**

3.5-5-3.5





540 SQFT



3.5-5.5 DEEP

# TRANQUIL COVE

16 FOOT WALL WITH 3 WATER FEATURES  
5 LED COLOR CHANGING LIGHTS  
8X8 SUNKEN SPA WITH SLANTED BACKS &  
ARM RESTS



# LUXE LAGOON

**457 SQFT**

**5 LED COLOR CHANGING LIGHTS  
7X7 RAISED SPA WITH SPILLOVERS  
SLANTED BACKS & ARM  
RESTS IN SPA**

NORMAL DEPTH  
3.5-5.5



586 SQFT



3.5-5.5 DEEP

# SPARKLING SPRINGS

2 FIRE BOWLS & 30FT FIRE WALL

BEACH ENTRY

8X8 INFINITY SPA WITH SLANTED BACKS

AND ARM RESTS

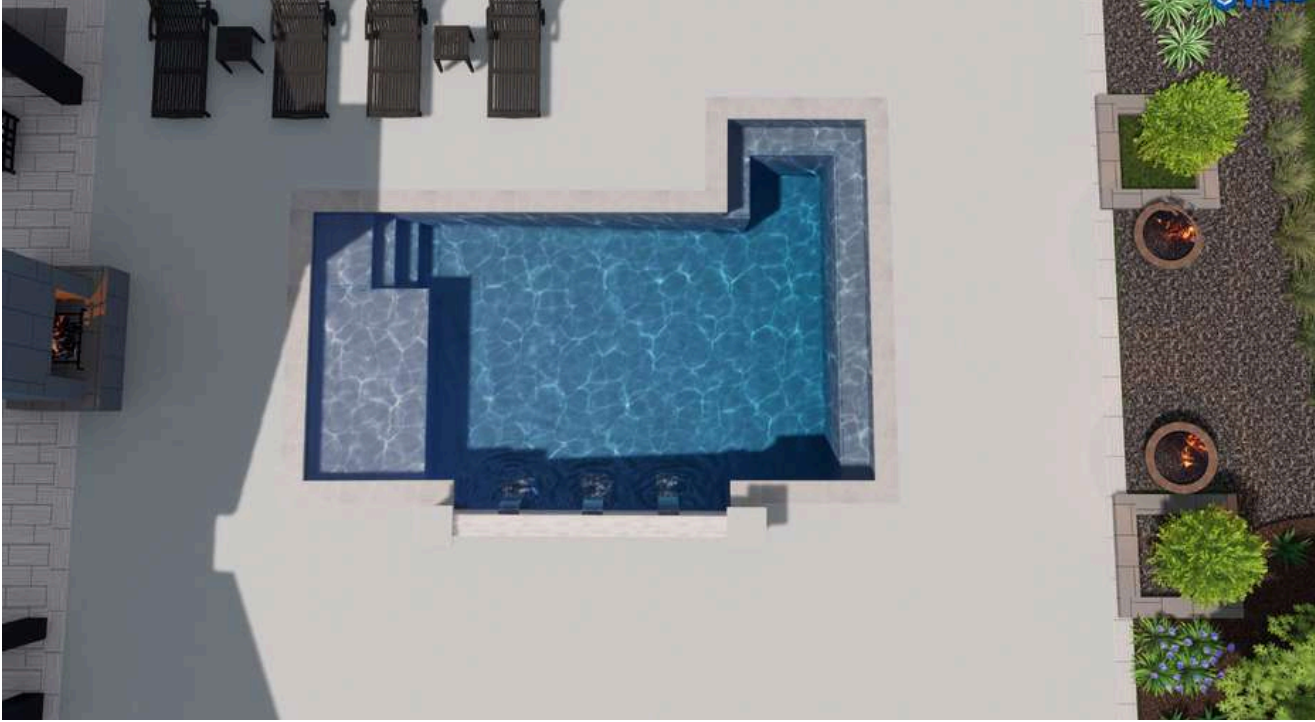

# TWILIGHT COVE

460 SQFT

4 LED COLOR CHANGING LIGHTS  
15FT WALL WITH 3 WATER  
FEATURES

NORMAL DEPTH  
3.5-5.5



570 SQFT



3.5-5.5 DEEP

# SERENE SHORES

- 13FT WALL WITH 3 FEATURES
- 5 LED COLOR CHANGING LIGHTS
- 8X9 SEATING AREA WITH SLANTED BACKS



# ELEGANT EDGE

**500 SQFT**

**12X5 TANNING LEDGE  
5 LED COLOR CHANGING LIGHTS  
4 DECK JETS**

NORMAL DEPTH  
3.5-5.5



368 SQFT



3.5-5.5 DEEP

# SILVER SANDS

4 LED COLOR CHANGING LIGHTS  
8X8 RAISED SPA WITH SLANTED BACKS &  
ARM RESTS



# SUNSET BAY

**450 SQFT**

**NORMAL DEPTH  
3.5-5.5**

**4 LED COLOR CHANGING LIGHTS  
8X8 SUNKEN SPA  
SLANTED BACKS & ARM  
RESTS IN SPA**





450 SQFT



3.5-5.5 DEEP

# PARADISE PLUNGE

4 LED COLOR CHANGING LIGHTS  
6FT WATERWALL

# POOL CONSTRUCTION CENTERED AROUND YOU

At Duplessis Builders, we believe the pool construction process should be efficient, collaborative, and completely centered around you. When it comes to your swimming pool, you have a vision, and it's our job to make it come to life.

## PURCHASING YOUR DUPLESSIS BUILDERS CUSTOM POOL

After agreeing to and finalizing the cost of your project, our construction manager will begin to create your detailed construction plans. These plans will allow us to obtain city and HOA approvals, if necessary, and ensure that every detail you choose to include in your project has been included. Once the plans are complete, we will send them to you for your approval and signature.

### CONSTRUCTION PLAN EXAMPLES

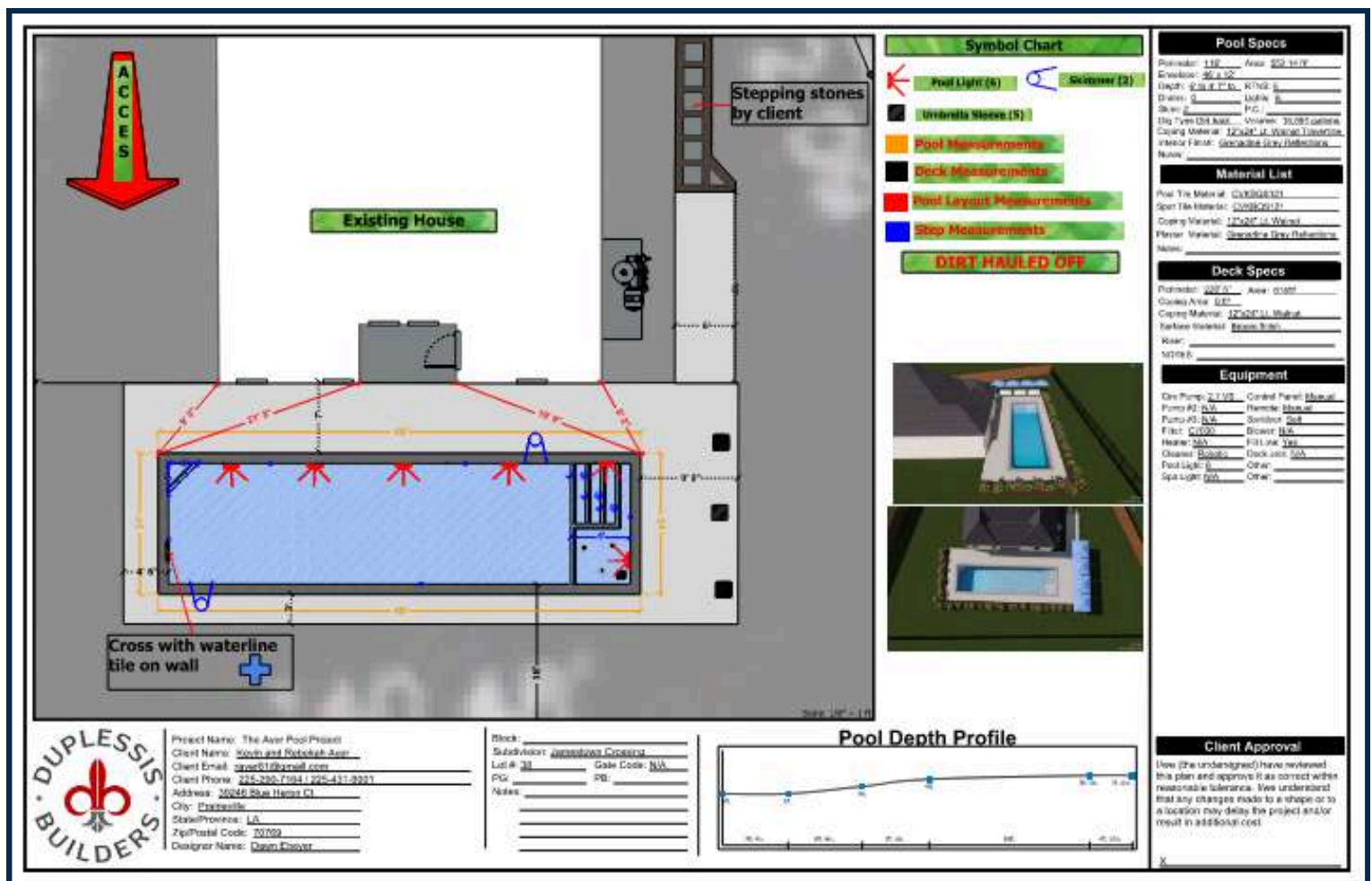

## POOL CONSTRUCTION CENTERED AROUND YOU



### LAYOUT

Once you have approved and signed off on your construction plans and we have submitted them for any necessary city and HOA approvals, a member of our construction team will contact you to schedule a layout meeting at your home. At this meeting, we will lay out the perimeter of your pool per the specifications of your approved construction plan. The project manager will use stakes, strings, and spray paint, to outline your pool, approximately 12 inches larger than the waterline, to accommodate for the thickness of the concrete gunite shell.

During this step of the process, we will submit an 811 request to verify underground utility locations. You will be contacted by any company that has underground utilities on or near your property. These companies typically include electric, water, gas, cable, phone, Wi-Fi, and other communication lines.

When the layout has been completed and we are 100% certain there are no underground utilities in the excavation area, we will walk you through our layout agreement and you will sign off on the necessary paperwork.



# POOL CONSTRUCTION CENTERED AROUND YOU

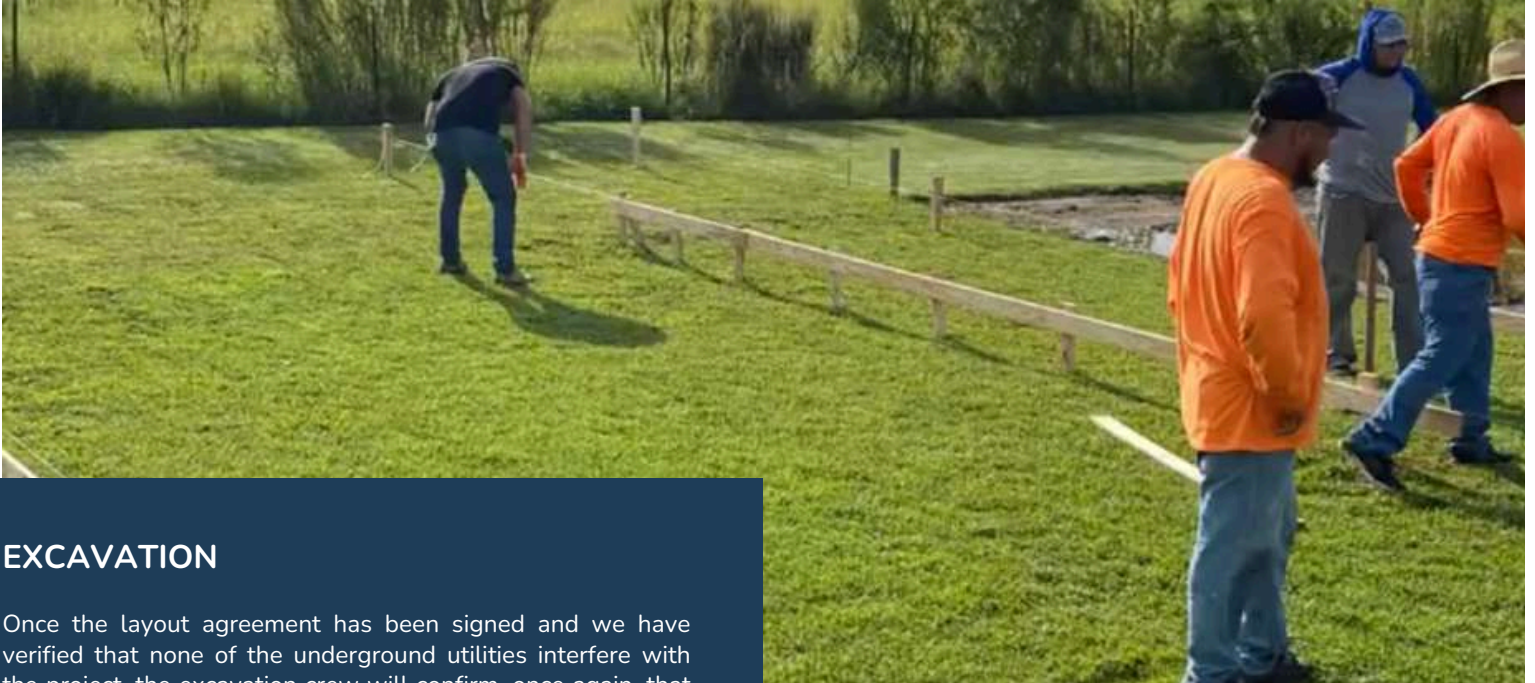

## EXCAVATION

Once the layout agreement has been signed and we have verified that none of the underground utilities interfere with the project, the excavation crew will confirm, once again, that the layout of the swimming pool is correct and in accordance with the final construction plans. They will then install the forms, remove the access fence, and begin the process of removing the necessary dirt.



## POOL CONSTRUCTION CENTERED AROUND YOU

### STEEL AND PLUMBING

Once the pool has been excavated, the crew will start on the steel reinforcement and plumbing. They will excavate a trench ~18" deep and run all of the lines in the trench to the equipment pad. Here the lines will penetrate the soil and be pressurized to 30 psig until the pool equipment is set.

The lights will also be ran in the same trench as the conduit. Lights will be 1-1/2" pipe where they penetrate the shell and have duct tape over the end. Pressure pipe will have pipe caps.

Inspections will be scheduled once this stage is complete. This step can take several days, depending on the local inspections office.



# POOL CONSTRUCTION CENTERED AROUND YOU

## GUNITE INSTALLATION, WATERING, & SITE CLEAN-UP

Once the steel and plumbing have been installed, the pool will be sprayed with gunite. Gunite is a reinforced concrete mixture that will make up the shell of the pool. The day after the gunite has been installed you will need to begin watering the shell twice a day for seven consecutive days. During this time, the cleanup crew will remove any excess gunite, remove forms, and prepare your yard for grading.

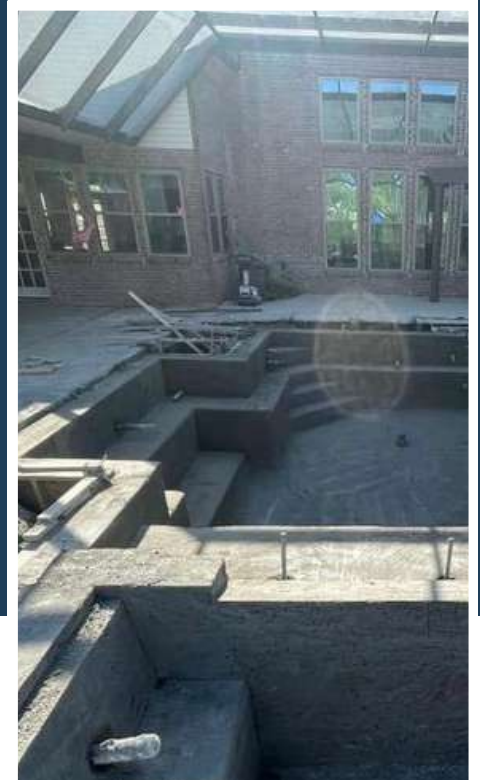

## POOL CONSTRUCTION CENTERED AROUND YOU



### TILE & COPING EXAMPLES



### TILE & COPING

Now that the underground systems and equipment have been installed, the next phase of construction will be the installation of your tile and coping materials. This installation includes waterline tile, pool coping, and any other additional features, such as raised walls, etc., agreed upon in the plan and design.



Once the tile and coping installation is complete, your project manager will schedule a mid-construction walkthrough to discuss the current progress of your project. The project manager will review all phases that have been completed as well as the phases that remain to be completed. After this walkthrough, you will be asked to sign off on the mid-construction walkthrough paperwork.

## POOL CONSTRUCTION CENTERED AROUND YOU



### DECK FORM & INSTALLATION

Once the tile and coping installation has been completed, the next step in the construction process is deck installation. Deck forms will be installed in accordance with the construction plan and inspection will be conducted. Next, concrete or other decking material will be installed in compliance with the construction plan. Finally, pool deck finishes will be installed. Pool deck finishes include pavers, natural stone, stamped concrete, and cool decking.

Following the completion of the deck installation, the cleanup crew will clean the construction site, remove concrete forms, and perform a final grading of the site.

After the final grade has been conducted, your fence will be reinstalled, and we will verify that access to the pool has been secured.

For the final step in this phase, the project manager will meet with you to go over the current progress of the swimming pool and have you sign off on the necessary walkthrough documents.





## POOL CONSTRUCTION CENTERED AROUND YOU



### EQUIPMENT, PLUMBING & ELECTRICAL

After the concrete has been completed, the pool equipment will be delivered to the site and verified for accuracy. Once the equipment has been verified; a plumber will begin to install the equipment and connect all necessary piping to the equipment pad.

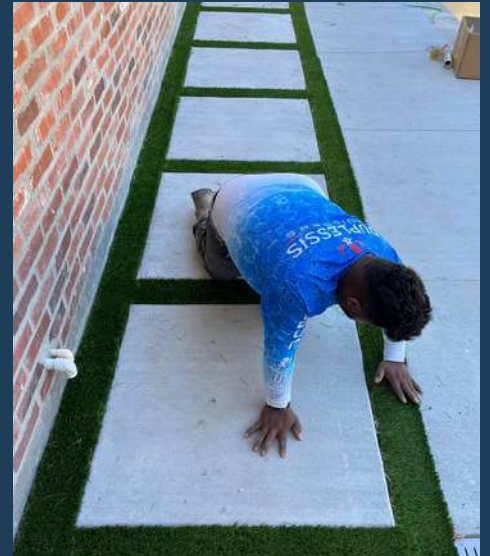

## POOL CONSTRUCTION CENTERED AROUND YOU



### INTERIOR FINISH INSTALLATION

After installing the interior finishes, the prep crew will clean and prepare the Gunitite surface. Next, the installation crew will install the final plaster finish or mosaic tile, as well as the pool accessories such as lights, returns, and drains.

### POOL FILL & STARTUP

Upon completion of the interior finish installation, the crew will begin to fill the pool with water. During this time, you will need to monitor the pool as it fills to ensure it does not overflow. As the interior finish cures, the pool will need to be brushed down periodically to remove materials and stains. We recommend brushing the entire pool at least twice per day for fourteen days.

Once the pool has filled with water, the startup team will start the pool equipment and verify that all pool equipment is working properly. The team will test all pumps, valves, filters, and lights, and add chemicals to the pool to help balance the water chemistry. Finally, they will set the pool to run 24 hours a day for several days to keep the water circulating.

The final step in this phase of construction is "Pool School." Pool school is a training where we schedule a pool professional to come to your house and review all the pool equipment and go over the procedures necessary for you to be able to properly use and maintain your new pool.

We will check back in with you after all final inspections have been closed. At this time, we will confirm that the pool is functioning properly and that you are 100% satisfied. We will also review how to clean your skimmers, test your water chemistry, answer any questions, and review any additional information needed.



## COMPLETED POOLS

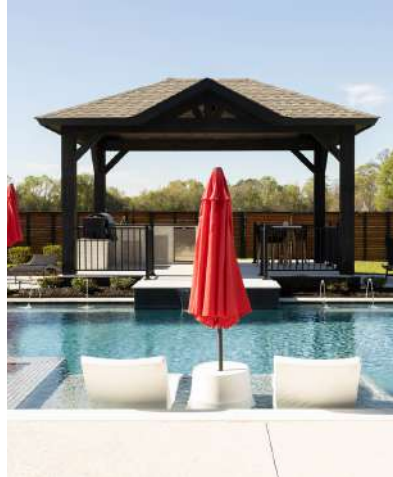



# COMPLETED POOLS





## COMPLETED POOLS

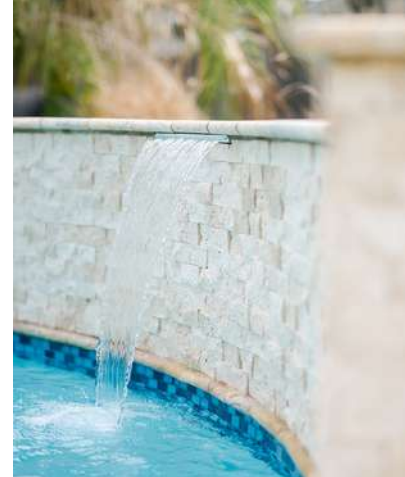

# TESTIMONIALS

## DUPLESSIS BUILDERS

---

### WHAT PEOPLE ARE SAYING ABOUT US

“

*Duplessis Builders has done amazing work in our backyard. We are beyond pleased with how everything has turned out. From a custom pool design that they came up with, to adding in a hot tub late in the design process, to bringing an outdoor fireplace dream to life, and then beautiful landscaping to tie it all in together. Derek was wonderful to work with, answering all of our questions and listening to all of our ideas to ensure we got the beautiful backyard we envisioned.*

”

**-Denise Carter**

“

*Derek's professionalism is beyond great. The communication is always on point. Any concerns we had were always addressed and taken care of. Derek and his team are extremely professional and super respectful. We had an amazing pool build with Duplessis!!!*

”

**-Jenna Duhe**

“

*“Positive: Professionalism, Punctuality, Quality, Responsiveness, Value  
Thank you again, Derek, Dawn, and the entire Duplessis Team for providing us with a top-notch pool-building experience! Your level of professionalism and work ethic are to be commended and are greatly appreciated by our family and neighbors! Our experience was truly the best from the beginning to the end!*

*If you want to work with great designers, consultants, builders, and a company that truly appreciates you as a client then choose Duplessis Builders!!!*

*Ps...Best part, we have so many favorite spots around the pool to choose from to enjoy our days!!! Great conversations, fun, games, relaxing afternoons and many memories are in our future, for all seasons!!!*

”

**-S Hayes**

# TESTIMONIALS

“

*I am writing to express our immense satisfaction with the new pool and pool house your team recently completed for us. The quality of craftsmanship, attention to detail, and professionalism displayed throughout the project have far exceeded our expectations.*

*From the initial consultation to the final touches, every step of the process was handled with the utmost care and expertise. Your design team perfectly captured our vision, creating a stunning outdoor oasis that seamlessly integrates with our home and landscape. The pool itself is not only beautiful but also built to the highest standards of safety and functionality. The pool house, with its elegant design and superior materials, has become a favorite gathering spot for our family and friends.*

*We also want to commend the dedication and hard work of your construction crew. They were punctual, courteous, and maintained a clean worksite. Any questions or concerns we had were promptly addressed, and the project was completed on schedule, which is a testament to your team's excellent project management skills.*

*Overall, our experience with Duplessis Builders has been nothing short of exceptional. We are thrilled with the final result and are already enjoying countless hours of relaxation and entertainment in our new space. We will not hesitate to recommend your services to anyone looking for high-quality construction and design.*

*Thank you once again for making our dream pool and pool house a reality. ”*

**-Kelly Cortez**

“

*This company was by far the easiest and most pleasant contractors that I have ever dealt with. They are still so responsive to all of my questions and any issue. If I had it to do all over again, I would definitely use Duplessis Builders again. We're very happy with our investment. ”*

**-Nakeitha Thomas**

“

*Duplessis did an amazing job. The project manager was always on site, including the owner himself. My phone calls were always answered. The pool was finished in a timely manner. The layout, lighting, and design are magical. Our pool looks amazing. ”*

**-Ashley Ray**

# TESTIMONIALS

“

*Derek with Duplessis Builders was nothing short of amazing!! He and his team are by far the most professional we have ever dealt with as far as contractors go. His eye for perfection is next to none. Their main concern is to finish your build even better than you would envision. Some people say pool builds are a nightmare but with Duplessis that was NOT the case!!! Great company with great people and a passion for pool building. ”*

**-Jenna Schexnayder**

“

*Duplessis Builders did a great job! The finished product is beautiful. What has been impressive too, is the post-construction responsiveness and care regarding any questions, pool management, and any minor punch-outs. Great group to work with if you are in the market! ”*

**-Bobby Franzo**

“

*Duplessis Builders has the best service and quality around! I highly recommend them for all your pool or outdoor needs. Derek is always quick responding to any questions or services I need. ”*

**-S Hayes**

“

*Excellent to work with from start to finish on our new pool. Dawn was great helping us get the pool and water features we wanted to fit in our backyard. The construction process went smoothly, and Derek and his crews got the job done sooner than expected. After the job was complete, Derek always responds quickly with our questions. We had an issue recently with the pool equipment and they came out that day and repaired the problem. Quality work and professionalism from their team. I highly recommend Duplessis Builders for your new pool. ”*

**-Brandon Bellard**



# TESTIMONIALS

“

*Hands down the BEST pool builder in the business. From designing our dream pool, to executing and delivering the finished product, We could not be Happier. The level of customer service and Quality that we have experienced with Duplessis Builders is unmatched. They kept us informed throughout the entire process and exceeded ALL of our expectations. We interviewed at least a dozen pool builders before choosing. Duplessis is the ONLY company who made us feel confident knowing that they will stand behind their work and make any wrong right. Just like with any other building project, we had a few hiccups along the way. However, I am extremely Thankful that we chose Duplessis because they worked through every situation and made us 100% happy. If we ever have the opportunity to build another pool Duplessis will definitely be our one and only choice.*”

**-Johnette Tolliver**

“

*We had an amazing experience with Duplessis Builders. After interviewing three different pool companies, we felt most comfortable with them, and it turned out to be the best decision. The design team was incredibly patient and helpful in assisting us with picking out the perfect pool finishes (shoutout to Dawn and Derek's daughter!). The owner, Derek, is top-notch, ensuring that every aspect of the work is done right. He personally approves all the work and insists on redoing anything that doesn't meet his high standards. His team takes their time to deliver quality results and offers the best warranty in the area. Even after the build, they've been incredibly responsive to all our questions. We've been in the pool every weekend, and it's truly been the best decision! I can't say enough great things about the owner and his team!*”

**-Melissa Polland**

“

*Wow!! From design process to the day they told us we are free to jump in these guys have been a dream to work with. They went way above and beyond for us. We are super happy we chose them to build our dream pool. We would 100% choose them for any future projects.*”

**-Jeff Tucker**

# TESTIMONIALS

“

*Derek and his team did a great job on our pool from the first meeting, custom design, to the construction of our pool and spa. I highly recommend Duplessis Builders!*”

**-Robby Moore**

“

*We had a great experience with Duplessis building our pool. We interviewed 9 different pool builders and we're very happy we chose Duplessis. Our pool turned out great, they did it within the time frame they told us they would, they cleaned up the usual construction mess (that was a huge bonus to us - we did not expect that) and their service after the completion has been great, too! I've heard a lot of horror stories about pool builders, but you'll be safe with these guys. I wish I could give them more than five stars. They deserve it.*”

**-Cori Rodgers**

“

*EXTREMELY SATISFIED!! Starting with Dawn - pool information and design and then Todd and ALL of the builders, I've not seen so much attention given to 'detail'. Kind, courteous, professional, prompt, knowledgeable. Love our salt water, gunite pool. And handicap lift installed. Highly Recommend. OK, Time to go swimming!!!*”

**-Donald Brown**

“

*They did an amazing job with my pool. Listened to everything I wanted and made it happen!*”

**-Stephanie Rubio**

“

*We are extremely happy with our pool and overall experience. Derek always goes the extra mile and works with excellence!*”

**-Kayli Mayeaux**

# TESTIMONIALS

“

*Duplessis Pools did a fantastic job transforming our pool from a vinyl liner to a gunite pool in an existing screened in closed area. We have totally enjoyed our renovation! They were also timely in addressing getting a part that needed replacing under warranty a year later. We highly recommend this company and also having a consultation with Derek- the owner in the planning stages. He is extremely knowledgeable!*

”

**-DeEtte Dearmond**

“

*Duplessis Builders is the best!! They built us the most amazing beautiful pool and spa. From our first meeting to project completion they have been highly professional and kept us informed. They do things right! Do yourself a favor and give them a call if you are ready to build that backyard oasis*

”

**-Linda Labure**

“

*We love our pool from Duplessis! We also enjoyed all the people and involved in the design, construction and maintenance consulting. We 100% recommend them!*

”  
**-Rebekah Ayer**

“

*Dawn at Duplessis Builders exceeded my expectations by going above and beyond to assist me, even though I wasn't a customer of Duplessis Pools. Her dedication and expertise in pool materials, pricing, and style were evident as she generously provided guidance in choosing the perfect design. Highly commend her exceptional service!*

”  
**-Katie White**

# 10 REASONS TO CHOOSE DUPLESSIS BUILDERS

At Duplessis Builders we believe that keeping up with industry standards as well as consulting education is of utmost importance. Therefore, our staff members attend annual trainings.

01

At Duplessis Builders we carry a two-million-dollar general liability policy and worker's compensation policy.

02

Duplessis Builders requires all our subcontractors to carry a one-million-dollar general liability policy as well as worker's compensation.

03

Duplessis Builders is a member of the Pool and Hot Tub Alliance.

04

We currently hold an A+ rating with the Better Business Bureau.

05

Our business office and showroom are conveniently located at 12380 Highway 44, in Gonzales, LA.

06

We have an extensive referral contact list upon request.

07

Our company offers a true lifetime structural warranty on the structure of your swimming pool. As well as a 10-year workmanship warranty.

08

Duplessis Builders offers an exclusive "Pool School" program following the completion of your new swimming pool.

09

Our company website is [www.duplessisbuilders.net](http://www.duplessisbuilders.net).

10

See Page 3 for our meet the team!

## DUPLESSIS BUILDERS WARRANTY

Duplessis Builders (DB) warrants that the pool structure will remain structurally sound for the period that the pool is owned by the contracted party. The term “structurally sound” means that the swimming pool can hold/retain water. In the event of failure to do so, DB will, within this time frame, repair the pool structure so that it will retain water once again. If this work requires repair of tile, coping, or plaster finish, these items will be repaired without charge. Plaster areas that cannot be matched because of normal usage discoloration, will be patched as near to the original color as possible.

Product	Warranty
Gunite Shell	Lifetime
Pebble Plaster Finish	15 years
Heater	3 years
Coping	10 years
Integral Parts	3 years
Skimmers	10 years
Pool Controls	3 years
Tile	10 years
Filter	3 years

# 10 QUESTIONS TO ASK OTHER POOL BUILDERS

At Duplessis Builders we understand that building a pool is a big decision and like any major purchase we know you will be looking for and comparing several builders. Therefore, we have included a few key questions to ask other potential builders.

01

Do you carry general liability insurance?

02

Are all your sub-contractors insured?

03

Is your company a member of the Pool and Hot Tub Alliance (PHTA)?

04

Is your company a member of the Better Business Bureau?

05

Do you have an office with a showroom?

06

Do you have a referral list?

07

Does your company offer a lifetime warranty?

08

Do you offer maintenance training after the pool is complete?

09

Does your company have a website?

10

Does your company have its own specialized team?

# CONTRACTOR COMPARISON SHEET

Contractor	DB		
Licensed	(Y) RL886909		
Insured	(Y) IMM GL & WC		
Permits	Yes		
Remove Dirt from site			
Swimming Pool			
Pool Size			
Light (s)			
Pump (s)			
Tanning Ledge Size	FREE		
Bubbler (s)	FREE		
Bench Length	FREE		
Spot tile	Y		

## CONTRACTOR COMPARISON SHEET

Contractor	DB		
Water Feature(s)			
Water Feature (s)			
Cleaner	Robotic		
Coping Material			
Tile	Glass or Porcelain		
Sanitation System			
Skimmer			
Startup Chemicals	All Included		
Handrail			
<b>Spa</b>			
Raised or Sunken			
Slanted Back & Arm Rests	Standard		



# CONTRACTOR COMPARISON SHEET

Contractor	DB		
<b>Spa Continued</b>			
Adjustable Spa Jets	8 Standard		
Stone Veneer			
<b>Decking</b>			
Deck Size (sqft)			
Deck Finish (Stone or Spray Deck)			
Deck Drain	4" Standard		
Reinforcement in Decking	#3 Rebar 18" OC		
Urethane between Coping and Decking	Standard		

# CONTRACTOR COMPARISON SHEET

Contractor	DB		
<b>Setting Materials Used</b>			
Sealing and Waterproofing of the Shell	Laticrete Hydroban - Limited Lifetime Warranty		
Mortar or Thinset for Coping	Laticrete 4XLT - Lifetime Warranty		
Thinset Used for Tile	Laticrete 254 Platinum - Lifetime Warranty		
<b>Other Subs Needed?? (DB is Turnkey!)</b>			
Electrician	Included in Standard Package		
Plumber	Included in Standard Package		
Final Grade	Included in Standard Package		

# CONTRACTOR COMPARISON SHEET

Contractor	DB		
Warranty			
Gunite Shell	Lifetime		
Plaster	10 Year Limited		
Waterproofing System	Limited Lifetime		
Underground Plumbing	10 Years		
Exposed Plumbing	10 Years		
Equipment	3 Year Manufacturer		
Warranty	10 Year		

## DISCOVER THE SPECTRUM OF POSSIBILITIES.

ColorLogic® LED lights come with 10 fixed colors and 7 color-changing light shows, plus 10 additional options when paired with automation, so it's easy to set the mood for any occasion.

### FIXED COLORS (10)



### PROGRAMMED LIGHT SHOWS (7)



Additional colors available when paired with Hayward® Omni® automation (10):



### COLORLOGIC & CRYSTALOGIC® LED LIGHTS

Available in 30, 50, 100, and 150 ft. cord lengths. The 'XXX' on the end of the SKU denotes length.

PRODUCT NAME	SKU	VOLTAGE	TYPE
<b>POOL &amp; SPA</b>			
Universal ColorLogic Pool Light	LPCUS11XXX	Low voltage	Color
Universal ColorLogic Spa Light	LSCUS11XXX	Low voltage	Color
Universal CrystaLogic Pool Light	LPLUS11XXX (300W)	Low voltage	White
	LPWUS11XXX (500W)	Low voltage	White
Universal CrystaLogic Spa Light	LSLUS11XXX (100W)	Low voltage	White
<b>1-1/2" LIGHTING</b>			
ColorLogic 320 Light	LACUS11XXX	Low voltage	Color
ColorLogic 160 Light	LYCUS11XXX	Low voltage	Color
CrystaLogic 320 Light	LAWUS11XXX	Low voltage	White
CrystaLogic 160 Light	LYWUS11XXX	Low voltage	White
<b>1/2" LIGHTING</b>			
ColorLogic 80 (50 ft. & 85 ft. cord lengths only)	LMCUS11XXX	Low voltage	Color
ColorLogic 80 & 40 LED Controller	LMCUSP005	Low voltage	N/A
<b>REPLACEMENT BULBS FOR INCANDESCENTS</b>			
ColorLogic LED Replacement Bulb	BPCUS11120	120V	Color

All Universal ColorLogic and CrystaLogic lights include **Smooth White** and **Silver Luster Starburst** trim rings. ColorLogic 320 & 160 lights include **Dark Gray** trim rings. Additional options include **Black, Gray** and **White**.

Additional rings to match your pool and spa are also available including: **White Starburst, Black, Blue, Beige** and **Gray**.

Universal ColorLogic LED lights are UL-listed to retrofit any existing niche from Hayward and other brands.

» [hayward.com/colorlogic](http://hayward.com/colorlogic) » 1-888-HAYWARD

Pumps » Filters » Heaters » Sanitization » Automation » Lighting » Water Features » Cleaners » Safety

Hayward, Hayward & Design, the H logo, ColorLogic, CrystaLogic, Omni, OmniLogic and Totally Hayward are registered trademarks and Expert Line, OmniDirect Mode and We Build Better are trademarks of Hayward Industries, Inc. All other trademarks not owned by Hayward are the property of their respective owners. Hayward is not in any way affiliated with or endorsed by those third parties. © 2021 Hayward Industries, Inc.

LITLEDAM21



 **HAYWARD**<sup>®</sup>  
We Build Better.™

## ColorLogic<sup>®</sup>

LED Pool & Backyard Lights

VIBRANT LED LIGHTS COMPATIBLE  
WITH OMNIDIRECT MODE™



**EXPERT LINE™**



ONLY FROM POOL PROS



3+ YEAR PARTS & LABOR WARRANTIES\*

\*When sold by a Totally Hayward® partner. Exclusions, other terms and conditions may apply — visit [hayward.com/expert](http://hayward.com/expert) for details.



# OmniPL<sup>®</sup>

Smart Pool & Spa Control

VERSATILE CONTROL WITH  
UNMATCHED VALUE



EXPERT LINE<sup>®</sup>



ONLY FROM POOL PROS



3+ YEAR PARTS & LABOR WARRANTIES\*

\*When sold by a Totally Hayward<sup>®</sup> Partner. Exclusions, other terms and conditions may apply—visit [hayward.com/expert](http://hayward.com/expert) for details.

# START DREAMING IN COLOR.

---

## Create the ultimate pool and backyard experience with ColorLogic® lights.

---

ColorLogic lighting lets you create any backyard ambiance you want, while saving you up to 86% on energy costs. Available in a variety of sizes, it's the easy way to turn any pool into paradise.

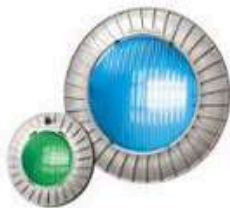

Universal ColorLogic LED pool and spa lights retrofit virtually any existing pool or spa while delivering best-in-class performance and illumination for truly vivid color.



ColorLogic 320 & 160 LED lights are perfect for low-profile pool and spa lighting or as accent lighting in landscaping or water features.



ColorLogic 120V LED pool bulbs retrofit most pool light fixtures for a total transformation in seconds.



ColorLogic 80 LED lights can be used wet or dry to illuminate hard-to-reach areas like steps, water features, landscaping, decking, sun shelves, waterfalls and more.

# START DREAMING IN COLOR.

---

## Create the ultimate pool and backyard experience with ColorLogic® lights.

---

ColorLogic lighting lets you create any backyard ambiance you want, while saving you up to 86% on energy costs. Available in a variety of sizes, it's the easy way to turn any pool into paradise.

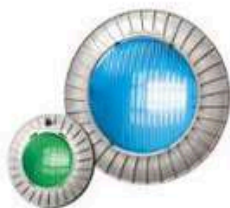

Universal ColorLogic LED pool and spa lights retrofit virtually any existing pool or spa while delivering best-in-class performance and illumination for truly vivid color.



ColorLogic 320 & 160 LED lights are perfect for low-profile pool and spa lighting or as accent lighting in landscaping or water features.



ColorLogic 120V LED pool bulbs retrofit most pool light fixtures for a total transformation in seconds.



ColorLogic 80 LED lights can be used wet or dry to illuminate hard-to-reach areas like steps, water features, landscaping, decking, sun shelves, waterfalls and more.





### COLOR AT YOUR FINGERTIPS.

The ColorLogic Light Controller puts the power of vibrant LED lighting anywhere you want it. Easily installed over any existing light switch, it lets you choose the perfect color for your pool from right inside your home using the convenient dial and preview window.



### EVEN MORE OPTIONS WITH OMNI<sup>®</sup> AUTOMATION.

Access additional capabilities with OmniDirect Mode<sup>™</sup> by pairing any low-voltage ColorLogic standalone light with Omni automation systems and the OmniLogic app. OmniDirect Mode offers:

- » Instant navigation to desired colors or light shows (no more cycling through every option)
- » Dimming capabilities (20% increments)
- » Speed adjustment for light shows
- » Access to 10 additional colors for increased customization opportunities (special occasions, sports teams, school colors and more)



# Universal HC Series

Dual-Fuel Technology Gas Heater

INDUSTRY'S SMALLEST  
FOOTPRINT HEATER\*



EXPERT LINE



ONLY FROM POOL PROS



3+ YEAR PARTS & LABOR WARRANTIES\*\*

\*Among leading competitive brands.

\*\*When sold by a Totally Hayward® Partner. Exclusions, other terms and conditions may apply — visit [hayward.com/expert](http://hayward.com/expert) for details.

## MINIMUM FOOTPRINT, MAXIMUM PERFORMANCE.

Universal HC Series dual-fuel technology gas heaters are uniquely engineered for use with Hayward® plumbing adapters, making them an easy drop-in replacement for other heater brands. The heat exchanger is made from cupro nickel for added reliability, and the easy-out air/gas mixing orifice makes propane conversion fast and simple. The industry's smallest footprint\* with zero wall clearance fits in even the most compact equipment pads, while the refined gas controls and remote connectivity provide a simple user experience with added service convenience.

**Top-access design** eliminates the need to remove side panels and kneel during service

**Quick-access reversible top** easily swaps plumbing from right to left while providing access to gas shutoff, voltage selection and more, all via a single fastener

**Cupro nickel heat exchanger** protects against water corrosion and natural wear

**Compact, lightweight design** makes installation easy in any environment



**Easy-out mixing orifice** allows for easy in-field conversion between natural gas and propane

**Low NOx emissions** meet clean air quality standards and offer premium heating performance

**Integral tie-down connections** on the base make for easy hand truck transport with no extra tie-down brackets required

### TECHNICAL SPECIFICATIONS

Model Number	HDF400	HDF275
Gas	Natural gas or propane	
BTU/hr	400,000	275,000
Thermal Efficiency	84%	
Heat Exchanger	Cupro nickel	
Hot Surface Ignition	Silicon nitride	
Combustion	Pre-mix	
Low NOx Emissions	Yes	
Digital Thermostat	Yes	
Remote Compatible	2-wire and 3-wire	
Supply Voltage	240/120 VAC	
Water Connections	2"/2.5"	
Gas Connection at Heater	3/4"	
Installation Location	Outdoor or indoor	
Footprint Dimensions (inches)	21" W x 21" D	
Heater Dimensions (inches)	28" W x 21" D x 31" H	
Heater Weight (lbs)	135	131
Shipping Dimensions (inches)	33" W x 33" D x 39" H	
Shipping Weight (lbs)	170	166



» **Patented butterfly bypass valve** enables flow rates up to 125 GPM without extra accessories



» **Exclusive plumbing adapters** allow for simple drop-in replacement with no pipe cutting required

### INDUSTRY'S SMALLEST FOOTPRINT HEATER.\*

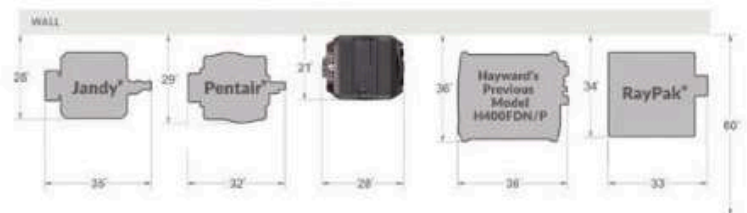

» [hayward.com](http://hayward.com) » 1-888-HAYWARD

Pumps » Filters » Heaters » Sanitization » Automation » Lighting » Water Features » Cleaners » Safety

\*Among leading competitive brands.

Hayward, Hayward & Design and the H logo and We Build Better. are registered trademarks of Hayward Industries, Inc. All other trademarks not owned by Hayward are the property of their respective owners. Hayward is not in any way affiliated with or endorsed by those third parties. ©2022 Hayward Industries, Inc.

LITUHC22

 **HAYWARD**  
We Build Better.



## TriStar® VS 950

Variable-Speed Pump

SIMPLE INSTALLATION WITH  
QUIETER-THAN-EVER PERFORMANCE



EXPERT LINE™



ONLY FROM POOL PROS



3+ YEAR PARTS & LABOR WARRANTIES\*

\*When sold by a Totally Hayward® Partner. Exclusions, other terms and conditions may apply — visit [hayward.com/expert](http://hayward.com/expert) for details.

**No-rib strainer basket with see-through cover** ensures easy debris removal

**Upgraded motor drive** delivers 30% quieter high-speed operation than other models

**Advanced hydraulic design** provides ample power to replace most high-performance pumps up to 3 HP



**Wall-mountable touchpad control** can be rotated in four directions

**Side and rear conduit entry** accommodate both high and low voltage connections for simple installation

**Permanent magnet, totally enclosed fan-cooled motor** offers more efficient operation and long-lasting reliability



**EXPERT LINE™**  
ONLY FROM POOL PROS

**INDUSTRY-LEADING ENERGY EFFICIENCY**

As a member of the TriStar® VS family—the most energy-efficient pumps in their class—TriStar VS 950 saves pool owners up to \$1,500 per year. Its ENERGY STAR rating means local energy rebates may apply, too.

**DESIGNED FOR DURABILITY**

Built with a chemical-resistant Viton® seal and accompanied by a 4-year extended warranty, TriStar VS 950 offers powerful corrosion protection for years of reliable performance.

**SEAMLESS RETROFITTING**

With dual-voltage capabilities, two pump base options and 2" x 2½" CPVC union connections, TriStar VS 950 is easy to install in both new and existing pool pads and doesn't require costly rewiring.



**SPECIFICATIONS**

MODEL NUMBER	TOTAL HP	VOLTAGE	WEIGHTED ENERGY FACTOR (WEF)*	UNION CONNECTIONS	WARRANTY
SP32950VSP	2.7	115V/230V	10.1/7.3	2" x 2.5"	3 years**

\*The higher the weighted energy factor (WEF), the more efficient the pump. Visit [hayward.com/regulations](http://hayward.com/regulations) for more information.

**TRISTAR VS 950 DIMENSIONS (INCHES)**

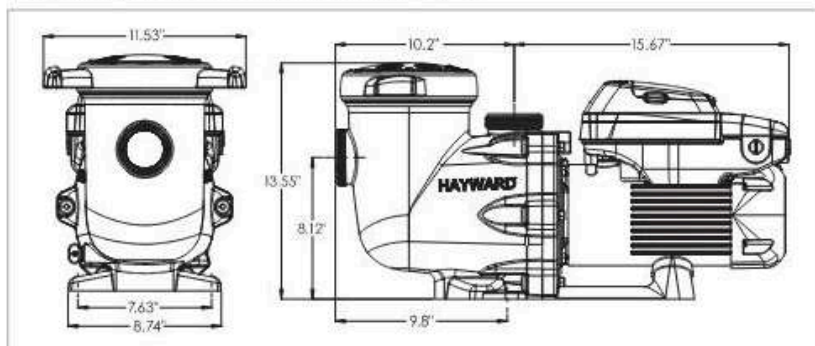

**TRISTAR VS 950 PERFORMANCE COMPARISON**

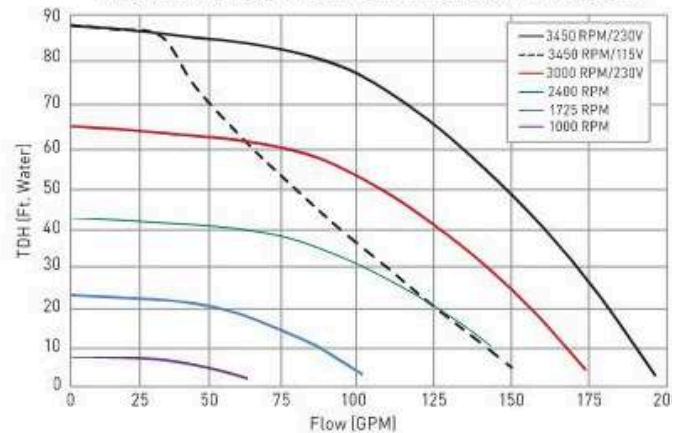

TriStar VS 950 pumps are listed by:

\*\*When sold by a Totally Hayward® partner. Exclusions, other terms and conditions may apply — visit [hayward.com/expert](http://hayward.com/expert) for details.

» [hayward.com](http://hayward.com) » 1-888-HAYWARD

Pumps » Filters » Heaters » Sanitization » Automation » Lighting » Water Features » Cleaners » Safety

Hayward, Hayward & Design, the H logo, Totally Hayward, TriStar and We Build Better, are registered trademarks and Expert Line is a trademark of Hayward Industries, Inc. ENERGY STAR is a registered mark owned by the U.S. government. All other trademarks not owned by Hayward are the property of their respective owners. Hayward is not in any way affiliated with or endorsed by those third parties. © 2022 Hayward Industries, Inc.

LITTSVS95022





# TriStar® VS

Variable-Speed Pump

PART OF THE INDUSTRY'S MOST ENERGY EFFICIENT FAMILY OF PUMPS\*



EXPERT LINE®



ONLY FROM POOL PROS



3+ YEAR PARTS & LABOR WARRANTIES\*

\*When sold by a Totally Hayward® Partner. Exclusions, other terms and conditions may apply — visit [hayward.com/expert](http://hayward.com/expert) for details.

**No-rib strainer basket with see-through cover** ensures easy debris removal

**Permanent magnet, totally enclosed fan-cooled motor** offers more efficient operation and long-lasting reliability

**Advanced hydraulic design** provides ample power to replace most high-performance pumps up to 1.5 full-rate or 2.0 max-rate HP



**Wall-mountable touchpad control** can be rotated in four directions

**Side and rear conduit entry** accommodate both high and low voltage connections for simple installation

**Upgraded dual-voltage motor drive** delivers 30% quieter high-speed operation than other models

**INDUSTRY-LEADING ENERGY EFFICIENCY**

As part of the TriStar family of pumps—the industry’s #1 pumps per Dept. of Energy standards\*—TriStar VS saves pool owners up to \$1,500 per year. Its ENERGY STAR rating means local energy rebates may apply, too.

**DESIGNED FOR DURABILITY**

TriStar VS is built to offer years of reliable performance.

**SEAMLESS RETROFITTING**

With easy top-mount wiring, two pump base options and 2" x 2½" CPVC union connections, TriStar VS is easy to install in both new and existing pool pads.



**SPECIFICATIONS**

MODEL NUMBER	TOTAL HP	VOLTAGE	WEIGHTED ENERGY FACTOR (WEF)**	UNION CONNECTIONS	WARRANTY
SP3202VSP	1.85	115/230V	12.9/8.3	2" x 2.5"	3 years

\*\*The higher the weighted energy factor (WEF), the more efficient the pump. Visit [hayward.com/regulations](http://hayward.com/regulations) for more information.

**TRISTAR VS DIMENSIONS (INCHES)**

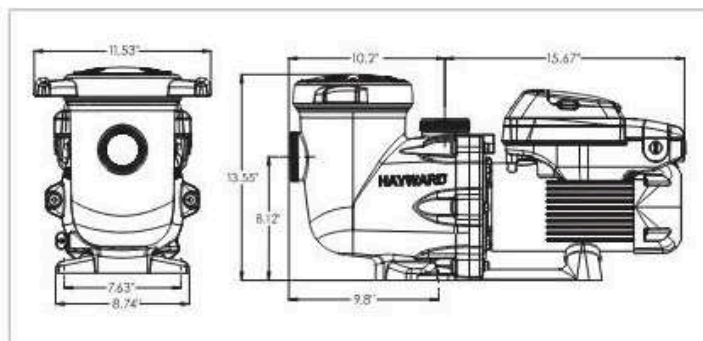

TriStar VS pumps are listed by:  

**TRISTAR VS PERFORMANCE COMPARISON**

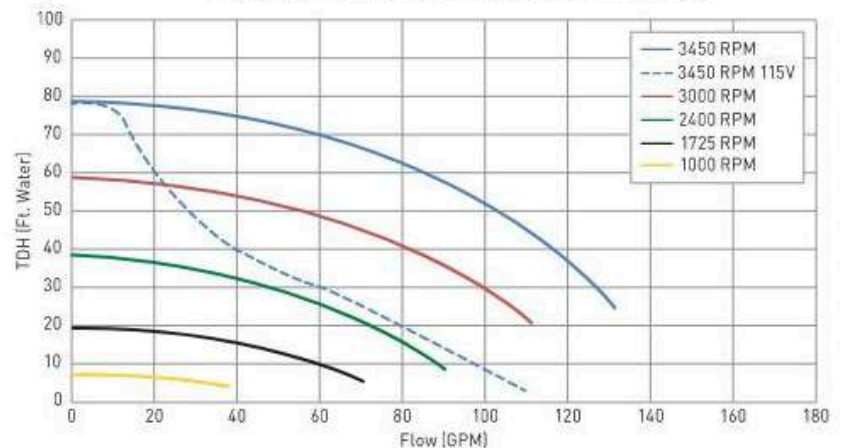

\*Claim based on TriStar VS 900 pump rating per Dept. of Energy efficiency metrics as of October 12, 2020. Visit [hayward.com/regulations](http://hayward.com/regulations) for details.

» [hayward.com](http://hayward.com) » 1-888-HAYWARD

Pumps » Filters » Heaters » Sanitization » Automation » Lighting » Water Features » Cleaners » Safety

Hayward, Hayward & Design, the H logo, TriStar and We Build Better, are registered trademarks of Hayward Industries, Inc. ENERGY STAR is a registered mark owned by the U.S. government. All other trademarks not owned by Hayward are the property of their respective owners. Hayward is not in any way affiliated with or endorsed by those third parties. © 2022 Hayward Industries, Inc.

LITTRISTVS22





# OmniHub<sup>®</sup>

Smart Pool & Spa Control

THE EASIEST WAY TO ADD CONTROL  
TO EXISTING POOLS & SPAS



EXPERT LINE<sup>®</sup>



ONLY FROM POOL PROS



3+ YEAR PARTS & LABOR WARRANTIES\*

\*When sold by a Totally Hayward<sup>®</sup> Partner. Exclusions, other terms and conditions may apply—visit [hayward.com](http://hayward.com) for details.



# DISCOVER THE POWER OF SIMPLE WITH OMNIHUB.®

OmniHub offers control over a full range of existing pool and spa equipment like pumps, heaters, lights, sanitization, water features and more. In just a few hours, you can easily install OmniHub for an in-ground or above-ground pool to control nearly any feature from the display, the OmniLogic® mobile app or popular voice control devices.



## PUMPS

Control speed & program schedule



## HEATER

Adjust temperature



## LIGHTS

Dim, schedule or change colors



## SALT SYSTEM

Monitor & set chlorination



## CLEANER

Schedule cleanings



## WATER FEATURES

Set schedules & themes



## SPA

Switch to spa mode



## COMPLETE CONTROL.

OmniHub works with popular automation systems you already use, including iPhone®, Apple Watch®, Amazon® Alexa® and Google Home®.



**Control Display** can be wall-mounted, features an intuitive touchscreen interface and maintains pool pad control even without internet connection



**Wiring Base Unit** offers connections for both high and low voltage wiring for easy configuration



**Smart Relay** converts existing equipment for control with OmniHub (connect up to three Smart Relays for additional control)



**OmniLogic App** offers total control of virtually any pool or spa feature

## OMNIHUB AND ACCESSORIES

MODEL NUMBER	DESCRIPTION
HLOMNIHUB	OmniHub® Smart Pool and Spa Control
HLH485RELAY	Omni® RS485 Smart Relay
HL485SPAKIT	Two Valve Actuators and Smart Relay
GVA-24	Valve Actuator 24 Volt
HLWIRELESS	OmniLogic® Wireless Waterproof Remote
HLSPASIDE	OmniLogic® Spa Side Remote
HL-CHEM	Sense and Dispense®
HLAQRPCB	AquaRite® Daughter Board
HLPMPCONV	OmniHub® Pump Converter Board
LTSUY11300*	SmartPower® Transformer

\*This SKU is for use with Hayward Omni Automation only

» [hayward.com](http://hayward.com) » 1-888-HAYWARD

Mobile phone not included with Omni products.

Pumps » Filters » Heaters » Sanitization » Automation » Lighting » Water Features » Cleaners » White Goods

Hayward, Hayward & Design, the H logo, AquaRite, Expert Line, Omni, OmniHub, OmniLogic, Sense and Dispense, SmartPower, Totally Hayward, Hayward We Build Better, and We Build Better, are registered trademarks of Hayward Industries, Inc. Apple, Apple Watch, iPad and iPhone are registered trademarks of Apple Inc. Amazon and Alexa are registered trademarks of Amazon Technologies, Inc. Android, Google and Google Home are registered trademarks of Google, LLC. None of these companies are affiliated with Hayward Industries, Inc. nor endorses this product. All other trademarks not owned by Hayward are the property of their respective owners. Hayward is not in any way affiliated with or endorsed by those third parties. © 2023 Hayward Industries, Inc.

**HAYWARD**  
We Build Better.

LITOMNIHUB23

# HEAT UP. COOL DOWN. SAVE BETTER.

VERSATILE HEATPRO 100K BTU AVAILABLE NOW.

READY  
TO SHIP!



#### HEAT & COOL

Utilizes cost-effective ambient heating tech



#### SAVE MONEY

Saves hundreds over 140K BTU unit



#### SAVE ENERGY

100K BTU is 12% more efficient than 140K BTU



#### SAVE SPACE

Requires just 6" wall clearance



HEATPRO® 100K BTU HEAT & COOL HEAT PUMP



Scan the code to learn more.

 **HAYWARD**

We Build Better.

# WHEN IT COMES TO PERFORMANCE, THIS HEAT PUMP DOESN'T CUT CORNERS.

- » **HEAT AND COOL CAPABILITY** with active defrost for low ambient temperatures
- » **MULTI-SPEED FAN** automatically modulates speed for quiet, energy-efficient operation (6.4 COP)
- » **COMPACT FOOTPRINT** requires only 6" rear clearance
- » **DURABLE COMPONENTS** like titanium heat exchanger and Gold Fin evaporator coil extend lifespan
- » **STANDARD PLUMBING UNIONS** (2" socket x 2.5" spigot) align with previous generation

## SPEED TO HEAT

(Based on 15x30 pool size)



**WINTER**  
ABOUT 1 HOUR MORE THAN  
HEATPRO 140K BTU



**SPRING/FALL**  
ABOUT 30 MINUTES MORE THAN  
HEATPRO 140K BTU



**EXPERT LINE**  
ONLY FROM POOL PROS



AHRI certified and independently lab-tested to ensure the highest quality performance and value.

## SPECIFICATIONS

<b>BTU HEATING PERFORMANCE</b>	<b>HP31005T</b>
80°F Ambient Air, 80°F Water, 80% Relative Humidity*	100,000
80°F Ambient Air, 80°F Water, 63% Relative Humidity*	94,000
50°F Ambient Air, 80°F Water, 63% Relative Humidity*	61,000
HEAT Operating Temperature °F	40
<b>COEFFICIENT OF PERFORMANCE (COP)</b>	
80°F Ambient Air, 80°F Water, 80% Relative Humidity*	6.4
80°F Ambient Air, 80°F Water, 63% Relative Humidity*	6.2
50°F Ambient Air, 80°F Water, 63% Relative Humidity*	4.2
Electronic Temperature Control	Yes
kW Input	4.7
Voltage	208-230/60/1
Minimum Circuit Amps	42
Minimum Overload Protection	50
Maximum Overload Protection	60
Water Flow Rate (GPM) Recommended Minimum/Maximum	30/75
Plumbing Connection	2" x 2 1/2" Unions
Refrigerant	R410A
Dimensions (inches)	31 1/2" DIA x 40" H
Net Weight (lbs.)	245
Shipping Weight (lbs.)	285



# AquaRite® S3

Salt Chlorination Systems

SUPERIOR SALT CHLORINATION  
WITH BUILT-IN POOL CONTROL



EXPERT LINE®



ONLY FROM POOL PROS



3+ YEAR PARTS & LABOR WARRANTIES\*

\*When sold by a Totally Hayward® Partner. Exclusions, other terms and conditions may apply—visit [hayward.com/expert](http://hayward.com/expert) for details.

# SALT CHLORINATION PLUS BUILT-IN CONTROL: THE SMARTEST WAY TO UPGRADE.

AquaRite® S3 offers all the benefits of silky-smooth water you'd expect from the #1 brand in salt water pools, along with versatile pool and spa control. With two model options and easy-to-add accessories, AquaRite S3 is more than superior salt chlorination—it's advanced sanitization and automation that grows with any pool.

## 1 START WITH SUPERIOR SALT WATER

AquaRite S3 automatically converts dissolved salt into a virtually endless supply of chlorine for perfectly sanitized pool water. Experience softer, silkier pool water that won't irritate eyes, dry out skin or fade fabrics—all while reducing chlorine costs by up to 50%.

## 2 CHOOSE THE LEVEL OF POOL & SPA CONTROL

AquaRite S3 offers basic control over salt chlorination, a heater and a variable-speed pump. AquaRite S3 Omni® gives you advanced control over pool and spa elements like water features, lights, cleaners and more from anywhere with the intuitive OmniLogic® app.

## 3 ADD ON ACCESSORIES (ANY TIME YOU WANT)

When you start with AquaRite S3, what you create is up to you. The system can be built upon at any time with easy-to-add accessories from smart relays to pH sensing to WiFi connectivity and more.



### AQUARITE S3

Superior salt chlorination plus control of chlorine output, a heater and a variable-speed pump via the convenient on-unit display, with the ability to upgrade to Omni if desired [AQRS30MNKIT].

Features a clear cell for easy inspection



### AQUARITE S3 OMNI

Superior salt chlorination plus full control of virtually any pool feature via the Omni control panel, the OmniLogic app and voice control devices including Amazon® Alexa® and Google Home®.

Features a clear cell for easy inspection

#### AQUARITE S3 SALT SYSTEMS AND PARTS

PART NUMBER	DESCRIPTION
AQRS315*	AquaRite® S3 Salt System 15,000-gallon
AQRS325*	AquaRite® S3 Salt System 25,000-gallon
AQRS340*	AquaRite® S3 Salt System 40,000-gallon
AQRS325OMNI*	AquaRite® S3 Omni® Salt System 25,000-gallon
AQRS340OMNI*	AquaRite® S3 Omni® Salt System 40,000-gallon

PART NUMBER	DESCRIPTION
AQRS30MNKIT*	AquaRite® S3 Omni® Upgrade Kit
TCELLS315	TurboCell® S3 Salt Cell 15,000-gallon
TCELLS325	TurboCell® S3 Salt Cell 25,000-gallon
TCELLS340	TurboCell® S3 Salt Cell 40,000-gallon
TCELLS340X25	TurboCell® S3 Salt Cell 40,000-gallon 25ft. cord

\*Works only with a genuine S3 Series Hayward salt cell.

» hayward.com » 1-888-HAYWARD

Mobile phone not included with AquaRite S3 Omni products

Pumps » Filters » Heaters » Sanitization » Automation » Lighting » Water Features » Cleaners » White Goods

Hayward, Hayward & Design, the H logo, AquaRite, Expert Line, Omni, OmniLogic, Totally Hayward, TurboCell, Hayward We Build Better, and We Build Better, are registered trademarks of Hayward Industries, Inc. Amazon and Alexa are registered trademarks of Amazon Technologies, Inc. Google and Google Home are registered trademarks of Google, LLC. None of these companies are affiliated with Hayward Industries, Inc. nor endorses this product. All other trademarks not owned by Hayward are the property of their respective owners. Hayward is not in any way affiliated with or endorsed by those third parties. © 2023 Hayward Industries, Inc.

**HAYWARD**  
We Build Better.

LITQRS3S23



# SwimClear™

Multi-Element Cartridge Filters

**CRYSTAL CLEAR WATER,  
SUPER DURABLE DESIGN**



**EXPERT LINE®**



ONLY FROM POOL PROS



3+ YEAR PARTS & LABOR WARRANTIES\*

\*When sold by a Totally Hayward® Partner. Exclusions, other terms and conditions may apply — visit [hayward.com/expert](http://hayward.com/expert) for details.

## MAXIMUM FLOW WITH MINIMAL MAINTENANCE.

Featuring an assembly of reusable polyester cartridge elements with precision-engineered cores, SwimClear multi-element cartridge filters provide heavy-duty dirt-holding capacity and extra-long filter cycles. In fact, as the industry's largest filter, the C7030 model offers the longest time possible between cleanings. SwimClear filters' top manifold configuration boasts industry-leading hydraulic performance, facilitating maximum flow through all cartridge elements for superior water clarity and increased energy savings.

### Reinforced co-polymer tank

is durable enough to withstand tough environmental conditions

### Low-profile tank base

makes removal of cartridge elements fast and simple



**Heavy-duty, tamper-proof, one-piece clamp** provides quick access to internal components without disturbing plumbing connections

**CPVC 2" or 2-1/2" union connections** provide maximum hydraulic performance with 2" plumbing

### SPECIFICATIONS

Filter Type	Cartridge elements: 225, 325, 425, and 525 ft <sup>2</sup> (4 cartridge elements), 700 ft <sup>2</sup> (8 cartridge elements)
Filter Tank	High-strength, injection-molded durable glass reinforced copolymer
Filter Element	Reinforced polyester
Performance Range	84 to 150 GPM, 318 to 568 LPM
Dimensions	C2030 – 24" W x 32½" H (58 cm x 81 cm) C3030 – 24" W x 34½" H (58 cm x 87 cm) C4030 – 24" W x 40½" H (58 cm x 102 cm) C5030 – 24" W x 46½" H (58 cm x 117 cm) C7030 – 24" W x 52½" H (58 cm x 134 cm)

### FILTER PERFORMANCE DATA

MODEL NUMBER	EFFECTIVE FILTRATION AREA	DESIGN FLOW RATE†	TURNOVER		CLEARANCE FOR HEAD REMOVAL	CARTON WEIGHT
			8 HOURS	10 HOURS		
C2030	225 ft <sup>2</sup> / 20.9 m <sup>2</sup>	84 GPM† / 318 LPM	40,320 gal / 153 kl	50,400 gal / 191 kl	15"	50 lbs.
C3030	325 ft <sup>2</sup> / 30.2 m <sup>2</sup>	122 GPM† / 462 LPM	58,560 gal / 222 kl	73,200 gal / 277 kl	16"	60 lbs.
C4030	425 ft <sup>2</sup> / 39.5 m <sup>2</sup>	150 GPM** / 568 LPM	72,000 gal / 273 kl	90,000 gal / 341 kl	18"	69 lbs.
C5030	525 ft <sup>2</sup> / 48.8 m <sup>2</sup>	150 GPM** / 568 LPM	72,000 gal / 273 kl	90,000 gal / 341 kl	22"	79 lbs.
C7030	700 ft <sup>2</sup> / 65.0 m <sup>2</sup>	150 GPM** / 568 LPM	72,000 gal / 273 kl	90,000 gal / 341 kl	28"	85 lbs.

†Based on NSF recommended rate for commercial use at .375 GPM/ft<sup>2</sup>

\*\*Determined by pump size and piping system hydraulics; 2" piping is recommended for flow rates equal to or greater than 90 GPM (341 LPM). Hayward doesn't recommend flow rates above 150 GPM.

\*When sold by a Totally Hayward® partner. Exclusions, other terms and conditions may apply — visit [hayward.com/expert](http://hayward.com/expert) for details.

» [hayward.com](http://hayward.com) » 1-888-HAYWARD

SwimClear Filters are listed by



Pumps » Filters » Heaters » Sanitization » Automation » Lighting » Water Features » Cleaners » Safety

Hayward, Hayward & Design, the H logo, Expert Line, Totally Hayward and We Build Better. are registered trademarks of Hayward Industries, Inc. All other trademarks not owned by Hayward are the property of their respective owners. Hayward is not in any way affiliated with or endorsed by those third parties. © 2023 Hayward Industries, Inc.

LITSCME23



We Build Better.®

# THE CONTROL YOU WANT AT A PRICE THAT WORKS.

Total pool and spa control shouldn't consume all of your budget. That's why Hayward offers a broad range of OmniPL® options—so you can choose the features you need, and only pay for the automation you want. Designed to offer the same high-end capabilities as our industry-leading OmniLogic™ system, and now 40% smaller, OmniPL brings control for variable-speed pumps, salt systems, color lighting and more to any mid-range pool build or renovation.

## Salt system compatibility

either includes salt cell (PLUS-models) or is salt-ready for optional cell (S-models)

**External touchscreen display with 15-ft cord** for flexible installation and access

**Compatible with all OmniLogic remotes** for maximum control versatility



**OmniDirect Mode™** supports ColorLogic® LED lighting with 20 color options, 7 exclusive shows and precise control of dimming, speed and more

**Scalable modular relay system** comes with 4 relays but can be easily upgraded to 6 or 8

**Models with no sub panel are now available** for dealers pairing it to an existing sub panel

**OmniLogic app** gives W-models industry-leading mobile control

## UNBEATABLE VALUE

With robust features at an accessible price, and an expandable design that grows with pool owners' backyards, OmniPL is the total control package for any pool or spa.

## CONTROLS IT ALL

Designed to control up to 8 variable-speed pumps, color lighting, a salt system (S/PLUS-models only) and more, OmniPL offers full-featured management of any pool.

## VOICE CONTROL

W-models let pool owners control their backyards through voice control devices like Amazon® Alexa® or Google Home®

### OmniPL SYSTEMS, PARTS AND ACCESSORIES

PART NUMBER	DESCRIPTION
HLPRO4W	OmniPL — 4 Relay with App
HLPRO4SW	OmniPL — 4 Relay, Salt Ready with App
HLPLUS4W	OmniPL — 4 Relay, TCELLS340 Salt Cell with App
HLPRO4NW*	OmniPL — 4 Relay, No Sub Panel with App
HLPRO4NSW*	OmniPL — 4 Relay, No Sub Panel, Salt Ready with App
HLPROUPG	ProLogic® to OmniPL Upgrade Kit

PART NUMBER	DESCRIPTION
HLRELAY	OmniLogic Relay
HLH485RELAY	OmniLogic RS485 Smart Relay
HLWIRELESS	OmniLogic Wireless Remote
HLWALLMOUNT	OmniLogic Wall-Mount Remote
HLSPASIDE	OmniLogic Spaside Remote
TCELLS340	TurboCell® S3 Salt Cell for up to 40,000 gallons
HL-CHEM	Sense and Dispense®
P-KIT	Plumbing Kit for Salt Chlorination
GVA-24	Valve Actuator

\*\*Coming Summer 2023

» [hayward.com](http://hayward.com) » 1-888-HAYWARD

Wireless remote, phone and tablet are not included with OmniPL.

Pumps » Filters » Heaters » Sanitization » Automation » Lighting » Water Features » Cleaners » Safety

Hayward, Hayward & Design, the H logo, ColorLogic, Expert Line, OmniPL, OmniLogic, ProLogic, Sense and Dispense, Totally Hayward, TurboCell and We Build Better, are registered trademarks and OmniDirect Mode is a trademark of Hayward Industries, Inc. Google Home® is a trademark of Google, LLC., and Amazon® and Alexa® are trademarks of Amazon Technologies, Inc. Neither of these companies is affiliated with Hayward Industries, Inc. nor endorses this product. © 2023 Hayward Industries, Inc.

LITOMNIPL23

